

Forme · Formes · Shapes · Formen · Formas

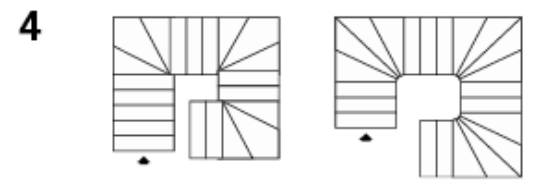

	G10	G11	G12	G13	G14	G15	G16	G17
	h	h	h	h	h	h	h	h
	1870	2040	2210	2380	2550	2720	2890	3060
	2310	2520	2730	2940	3150	3360	3570	3780

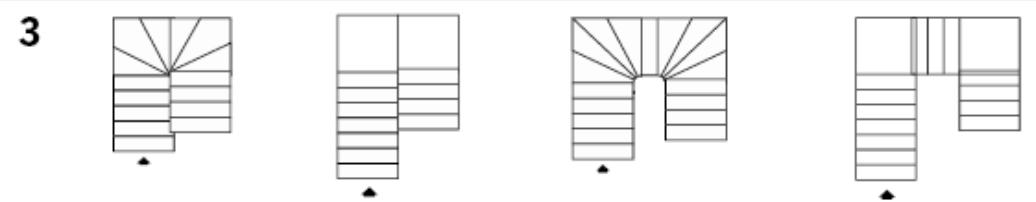
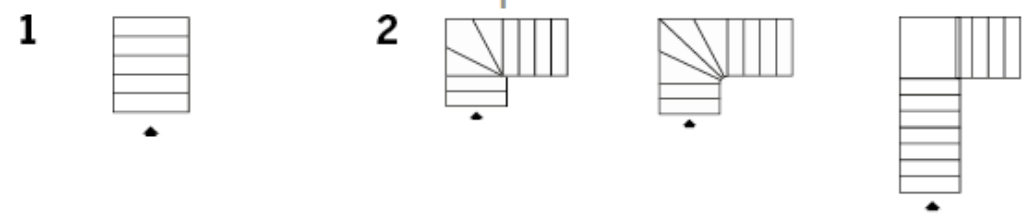

AKURA 50



AKURA 60



Caratteristiche tecniche

Technical specifications
 Spécifications techniques
 Technische Daten
 Características técnicas

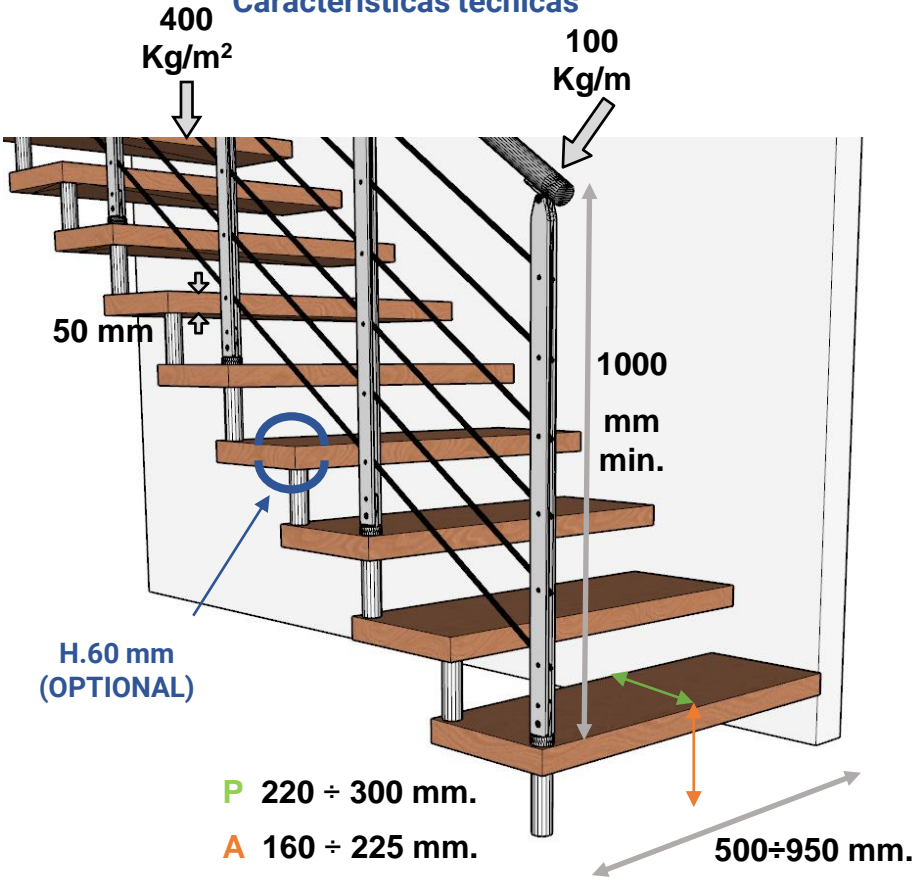

Tipologie di legno disponibili

Type of Wood
 Type de bois
 Holzart
 Tipo de madera



Faggio
 Beech
 Hêtre
 Buche
 Haya



Rovere
 Oak
 Chêne
 Eiche
 Roble

Calcolo passaggio utile

Useful passage - passage utile
 nützliche Passage - Pasaje útil

$$L - R (18,50 \text{ mm}) = P$$

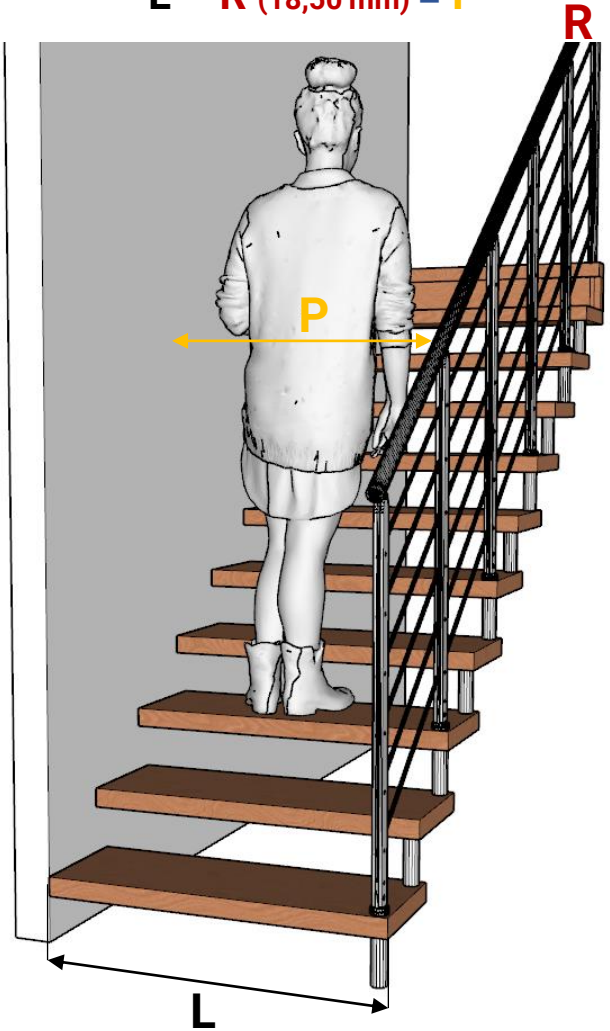

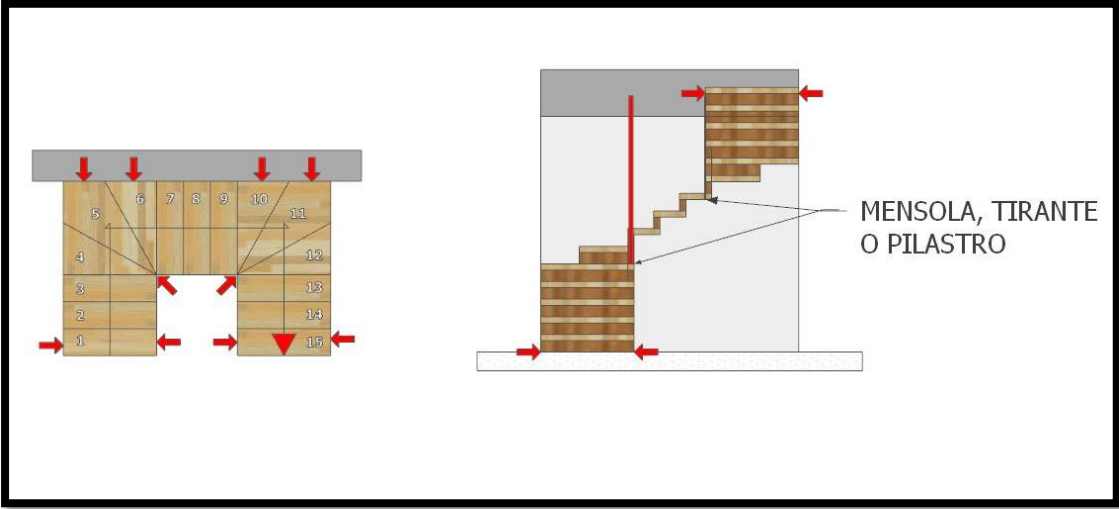
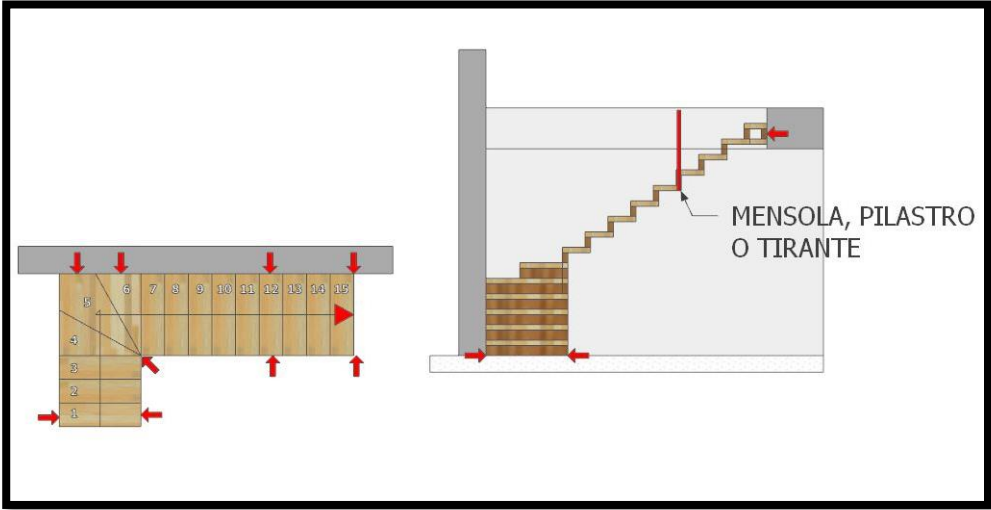
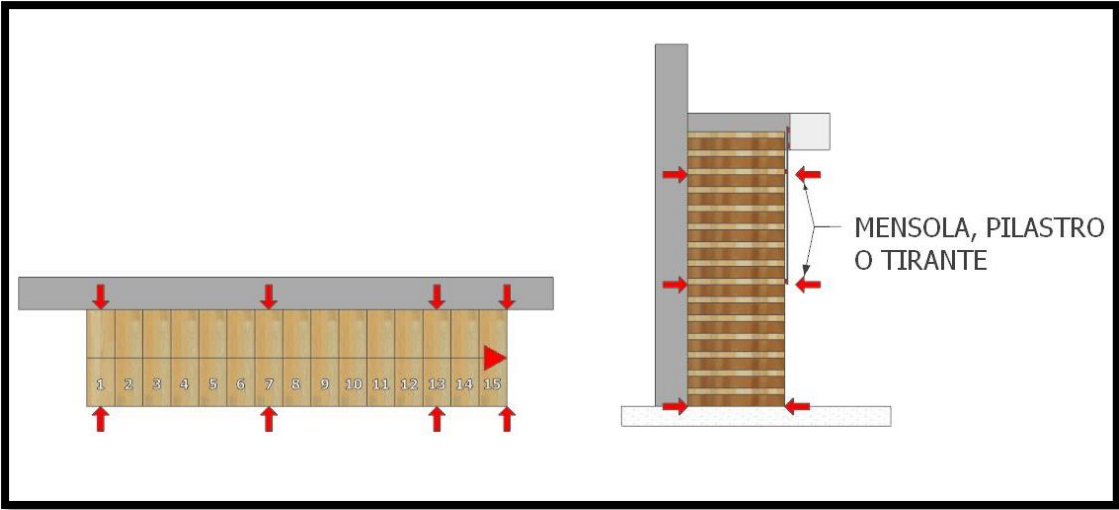

Tipologia di fissaggi: indicati con le frecce.
Fixations types: see the arrows
Types de fixations: suivre la flèche
Art der Befestigungen: folgen Sie dem Pfeil
Tipo de fijación: siga la flecha

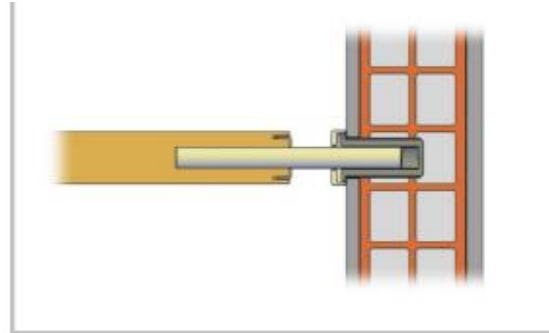
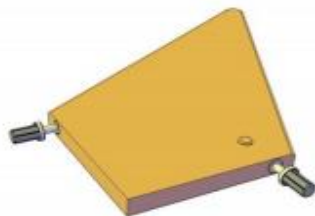
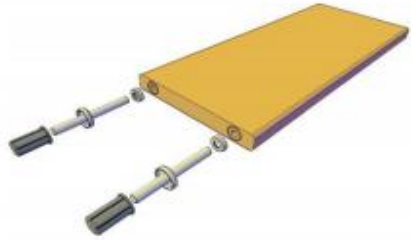

Tramezza
Partition wall
Cloison
Nicht Tragend Wand

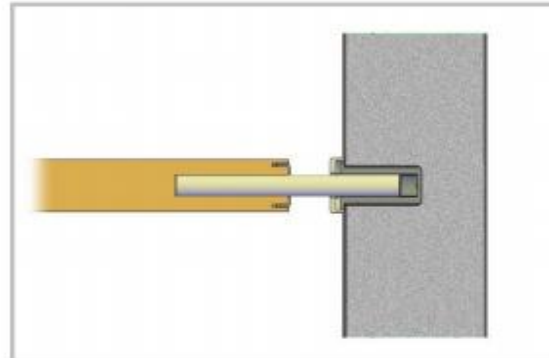

Portante
Bearing Wall
Mur portant
Hauptmauer

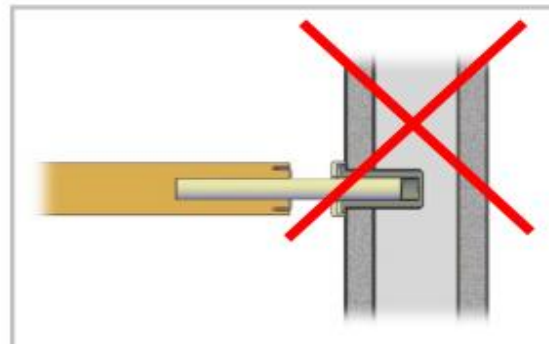

Cartongesso
Plaster board
Placoplâtre
Gipspappe

**Tutti i gradini vanno fissati al muro.
All steps must be fixed to the wall.
Toutes les marches doivent être
fixées au mur.
Alle Stufen müssen an der Wand
befestigt werden.
Todos los peldaños deben fijarse a
la pared.**

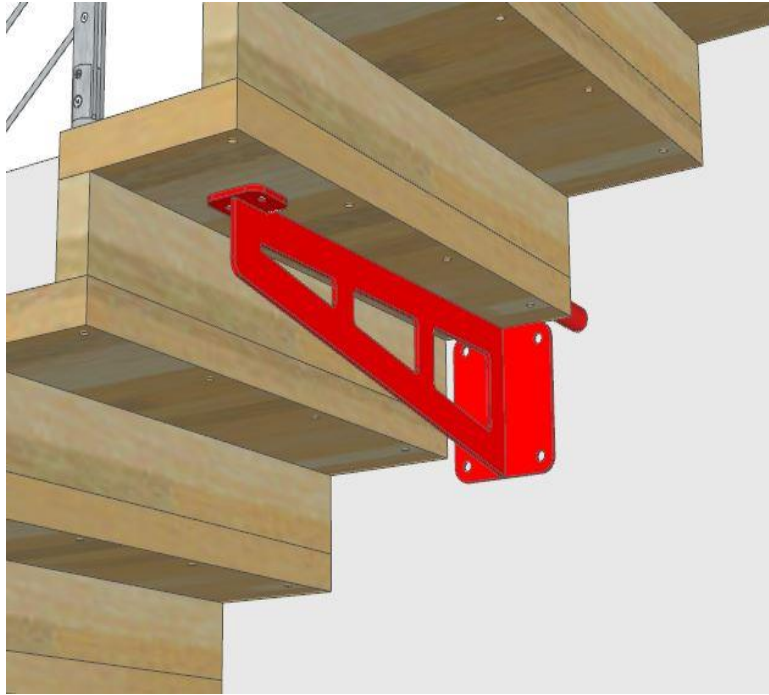

Mensola
Wall Bracket
Console au
mur

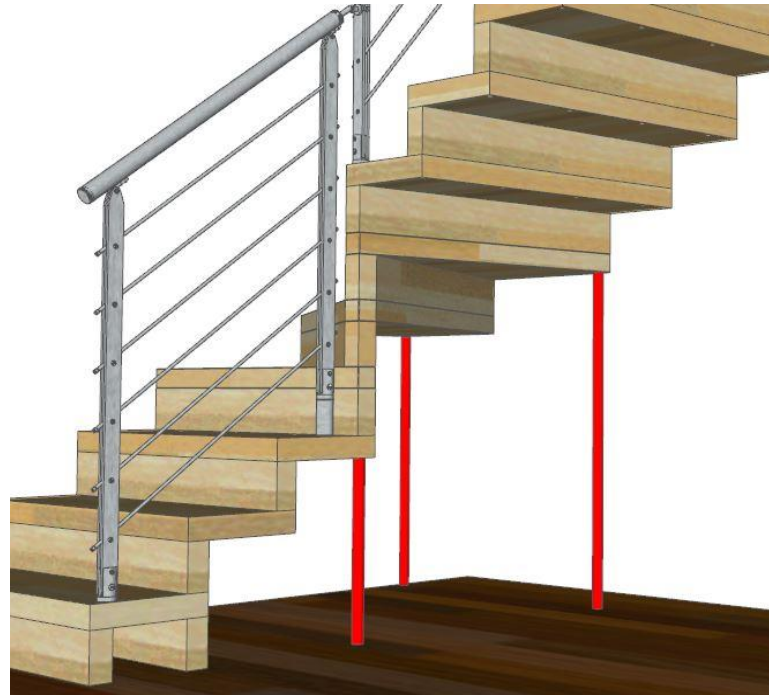

Pilastro
Support column
Poteau de soutien
Stutzsäule
Columna de apoyo

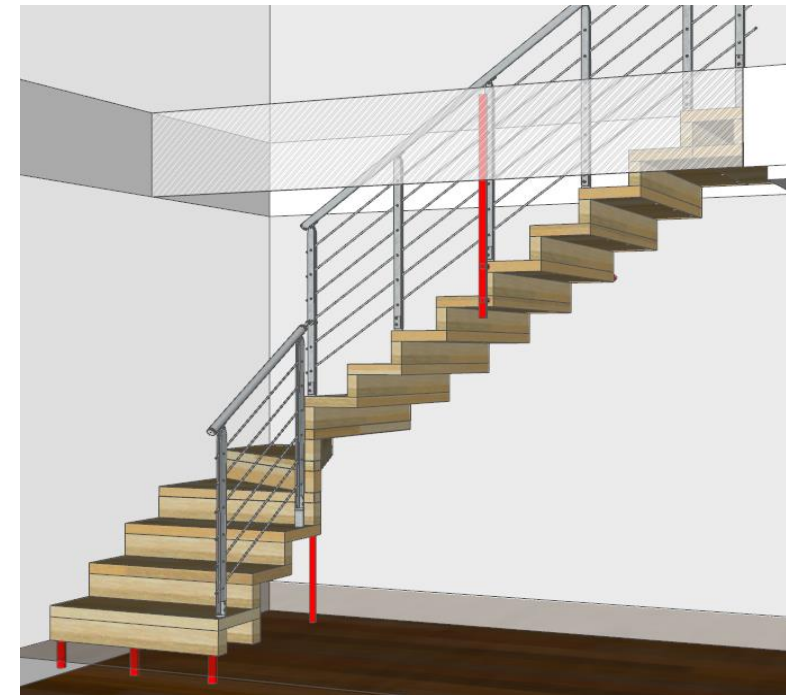

Tirante
Tie rod
Rotule de
direction

BALAUSTRATE DISPONIBILI

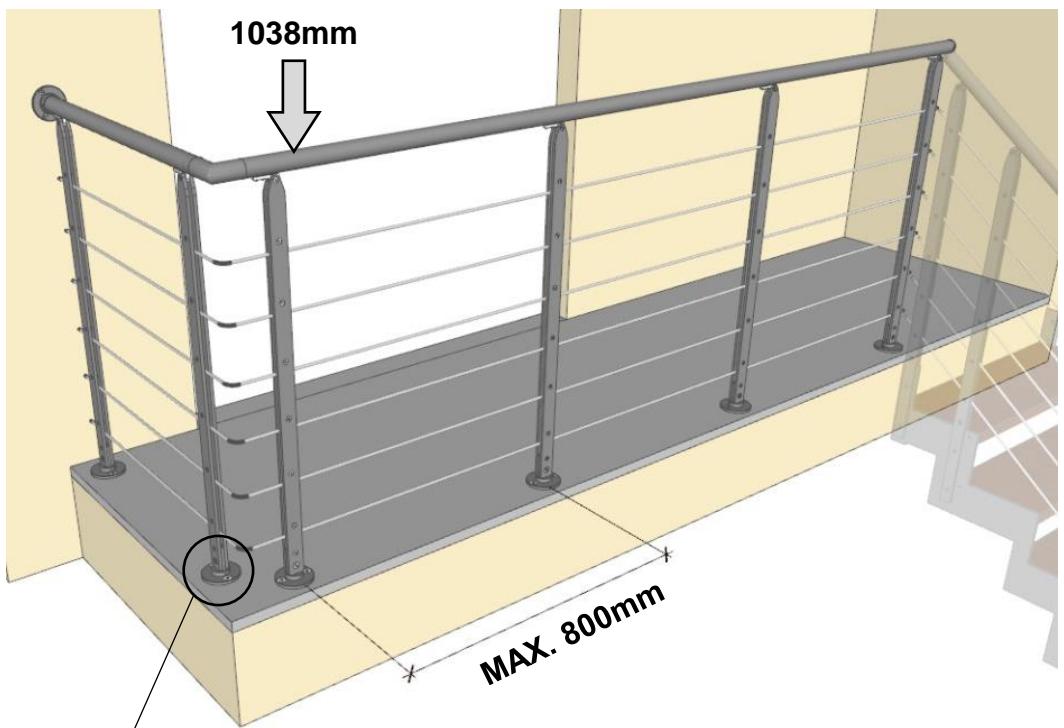

A PAVIMENTO

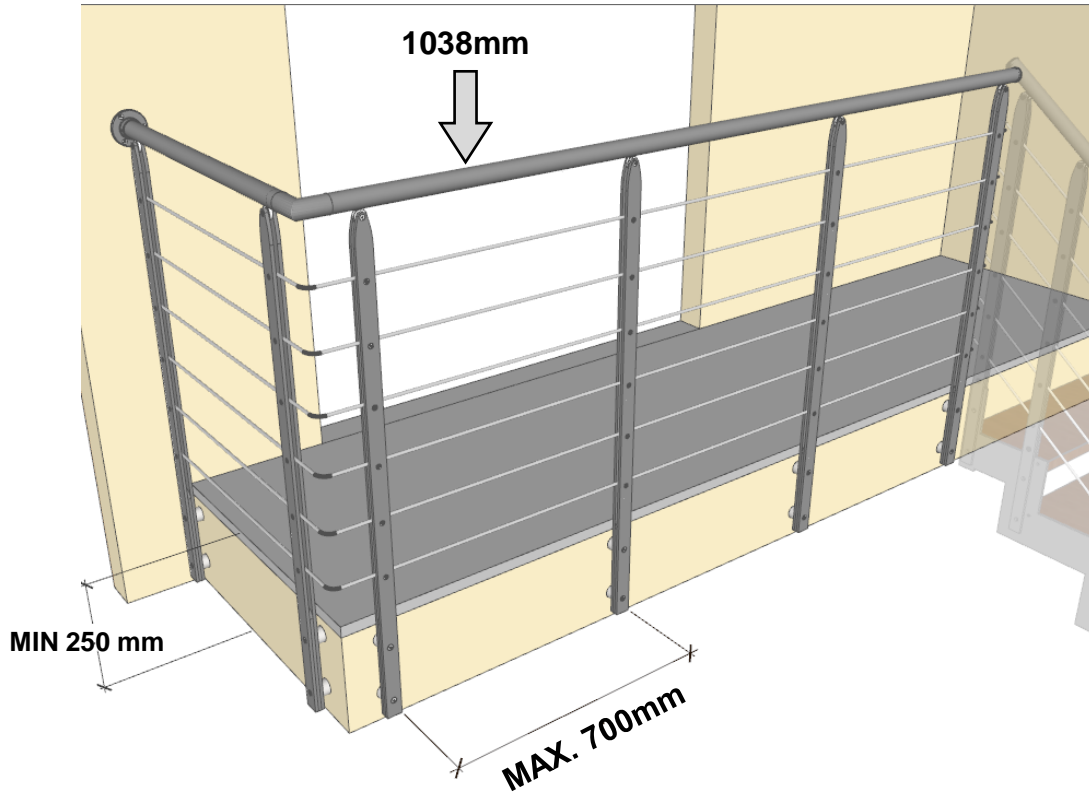
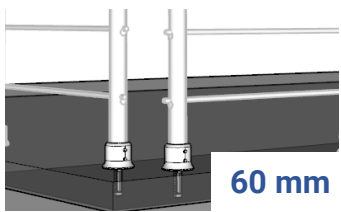

A SOLETTA

Alzate chiuse Closed Risers – Contremarches -
Setzstufen – Contrahuella cerrada

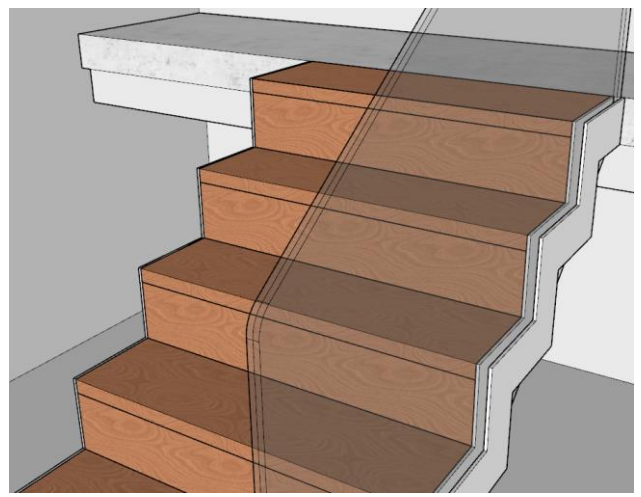

Angolo per pilastro (max 3 gradini) – Corner for Pillar
(max 3 steps) – Angle pour Poteau (max 3 marches) - Winkel
pro Säule (Max 3 Sufen) - ángulo por pilar (máximo 3
escalones)

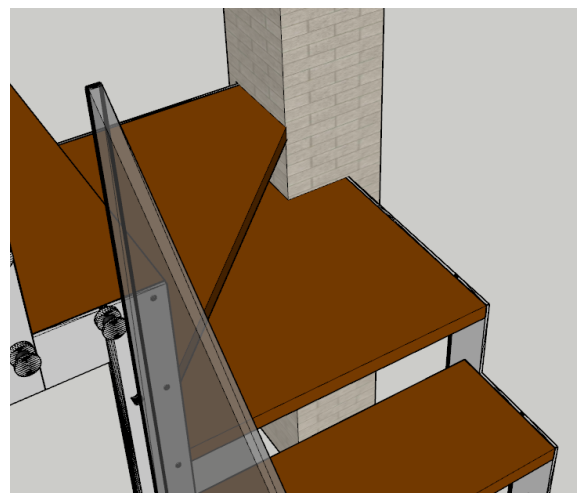

Scala fuori squadra
Out-of-square stair - Escalier hors équerre
Unregelmäßige Treppe – Escalera fuera de escuadra

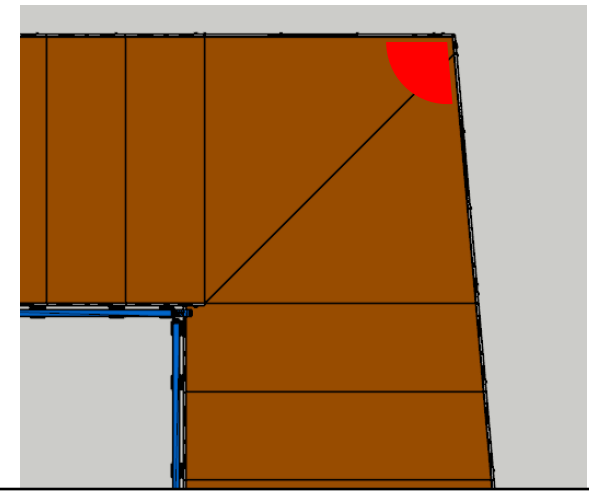

Corrimano a muro
Wall handrail – Main courante murale
Wandhandlauf - Pasamanos de pared



Soglia
Threshold – Seuil
Schwellenwert - Umbral

